

Solutions for measurement and monitoring of water activity

AVOID STALE SURPRISES



FOOD



PHARMA



COSMETICS



INDUSTRY

ro-tronic
MEASUREMENT SOLUTIONS

INTRODUCTION TO WATER ACTIVITY

Water activity is often called “free” or “non-chemically bound” water in foods and other products. Although these terms are easier to understand, they do not define all aspects of the concept of water activity.

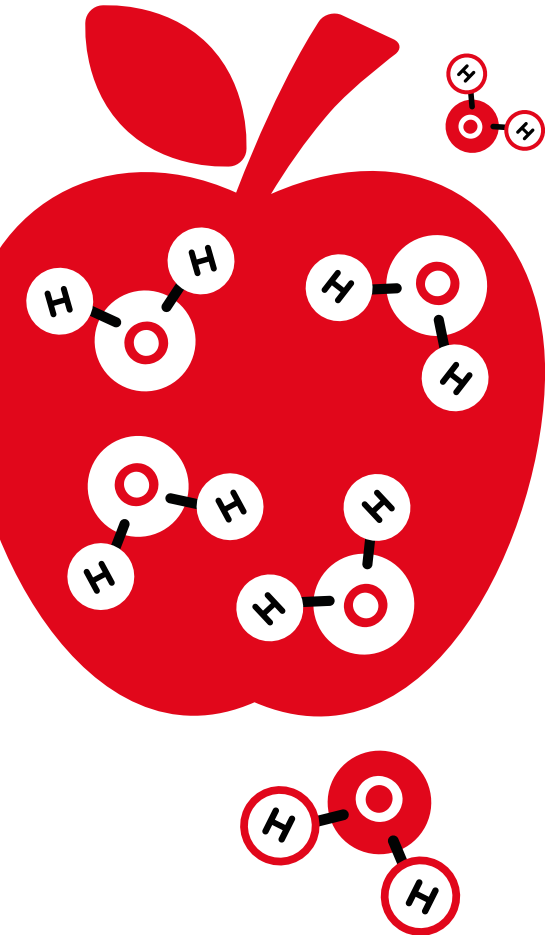

THE CORRECT DEFINITION

“Water activity – a measure for the energy status of the water in a system” specifies the relationship between the water vapor pressure of a product and the saturation pressure of pure water at the same temperature. It is stated in “aw” in the range 0...1 aw and is an important indicator for product quality in the industrial production of, for example, plastics. The determination of water activity is also very important in the food, tobacco, pharmaceutical and cosmetics industries. Water activity should not be confused with the water content – the “chemically bound” water – of a product.



Texture



Taste



Color



Nutritional value



Shelf life

Water activity influences the following properties of a product:

- microbiological stability
- chemical stability
- enzymatic stability
- color, taste and nutritional value
- protein and vitamin content
- stability of the composition
- shelf life
- storage and packaging
- solubility and texture

INTERESTED?



Scan the QR code for our water activity video or visit www.rotronic.com/aw



CONTENTS

Introduction to water activity	2
Applications	3
Product overview	4
Products	5–8
Software	9
Calibration	10
Theory	11
Rotronic worldwide	12

APPLICATIONS

All forms of life depend on water. Water activity indicates the amount of water which is biologically available to microorganisms. Each species of microorganism (bacteria, yeast, mold...) has a minimum water activity value below which growth is no longer possible.

Water activity plays an important role for product quality in various fields, including:

- Industrial manufacturing
- Food industry
- Pharmaceutical and Cosmetics industry
- Tobacco industry
- Seed storage

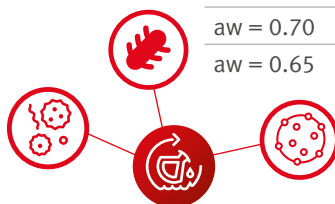

Water activity	Contaminant
aw = 0.91...0.95	Many bacteria
aw = 0.88	Many yeasts
aw = 0.80	Many mildews
aw = 0.75	Halophile bacteria
aw = 0.70	Osmiophile yeasts
aw = 0.65	Xerophile mildew

The US Food and Drug Administration (FDA) has adopted the concept of water activity for establishing limits beyond which certain types of foods are considered susceptible to mold and bacteria and have established the following table indicating which process control procedure can be used. It specifies pathogens of concern and control methods for various product categories (including examples of foods that may need to be evaluated for time/temperature control needs for safety).

Product category (examples of possible foods for evaluation)	Pathogens of concern	Types of process control 1 (alone and in combination)
Meats and poultry (fermented sausage)	Clostridium botulinum ⁵ and Clostridium perfringens, Salmonella spp., enterohemorrhagic Escherichia coli, Campylobacter...	Time/temperature, pH, aw , preservatives, moisture protein ratio, fermentation, heat processing
Fish and seafood (smoked fish)	Vibrio vulnificus, Vibrio parahaemolyticus, Vibrio cholerae, C. botulinum ⁵ , L. monocytogenes, Salmonella spp., Shigella spp., S. aureus	Time/temperature, harvest site control, fermentation, pH, aw , water-phase salt, preservatives, drying, salting
Cereal grains and related products (fresh pasta, foccacia bread)	Salmonella spp., S. aureus, B. cereus, C. botulinum ⁵	Cooking, aw , pH, preservatives, time/temperature

The water activity (*aw*) in foods can be controlled by using various additives (humectants), using satisfactory packaging materials and by maintaining favorable maturation and storage conditions. Should too much water be available, there is a risk of microbial growth and water migration. Food manufacturers today must prove to the FDA that the water activity of a product has been reduced sufficiently so that bacteria can't grow.

The water activity (*aw*) of a product will always try to reach equilibrium with the surrounding atmosphere. Water will migrate inside the product from regions with a high *aw* value to the regions of low *aw*. Water will migrate until equilibrium is reached! Therefore it is crucial to measure the water activity level of all components of a product as well as the ambient atmosphere to ensure the quality of a product. Water migration may cause the following issues: clumping, change of texture, reduced shelf life.

Water activity data may be used when deciding whether a product requires testing or not. The United States Pharmacopeia (USP) <1112> states that pharmaceutical drug products with water activities well below 0.75 would be excellent candidates for reduced microbial limit testing for product release and stability evaluation. Proposals exist stating that products with a water activity of 0.6 or less would not require routine testing for objectionable organisms.

PRODUCT OVERVIEW

Rotronic offers a complete range of products for measurement of water activity. The instruments are accurate and boast high efficiency, compatibility and simple calibration. Combine the measurement heads, insertion probes, benchtop display units and handheld instruments as you need.

Product overview	AwTherm	HygroLab C1	HP23-AW-A	HC2-AW-USB	HC2-AW-USB-SW	HC2-AW	HC2-P05	HC2-HP28	HC2-HP50
Measurement unit	✓			✓	✓	✓	✓	✓	✓
Display unit	✓	✓	✓						
Stationary	✓	✓		✓	✓	✓			
Portable			✓				✓	✓	✓
Interchangeable probe connector		4	2						
Probe connector fitted						✓	✓	✓	✓
USB port/connector	✓	✓	✓	✓	✓				
Ethernet interface		✓							
AwQuick function	✓	✓	✓		✓				
Includes PC software HW4-P-Quick	✓	✓			✓				
Dew and frost point calculation		✓	✓	✓	✓	✓	✓	✓	✓
HW4 compatibility	✓	✓	✓	✓	✓	✓	✓	✓	✓
Temperature controlled	✓								

PRODUCTS

AWTHERM

Temperature-stabilized measurement

The AwTherm is a professional high-end laboratory analyser for temperature-stabilized measurement of water activity in the food, pharmaceutical, cosmetics and other industries.

The wide control range permits measurements to be integrated directly in the temperature controlled manufacturing or storage process. Water activity measurement reacts very sensitively to variances in temperature. Stabilizing the temperature prevents imprecise results due to external temperature influences. Tested at 25 °C, AwTherm therefore fulfills the requirements of ISO 21807 (Microbiology of food and animal feeding stuffs – Determination of water activity), which requires measurement at 25 °C.

Order code

AwTherm-PS14
AwTherm-PS40
AwTherm-SET
AwT-MHS
AwT-PS14
AwT-PS40

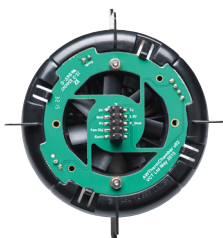

AwT-MHS: Interchangeable measurement head

Interchangeable measurement head

A further advantage of AwTherm is the removable measurement head, which means that the probe can be temperature calibrated or adjusted to achieve high precision.

User friendliness

In stand-alone use, the AwTherm excels with its easy handling and clarity and, together with the Rotronic HW4 software (FDA 21 CFR part 11 compliant), should be available in any laboratory.

Features

- Accuracy: ± 0.005 aw, ± 0.1 K
- Temperature control range: 0...60 °C
- High temperature stability: ± 0.01 °C / min
- Measurement repeatability: 0.002 aw
- Variable sample container sizes: 14 / 40 mm
- Interchangeable reference probes for cleaning or calibration
- Aw Quick function for fast measurement results (typically 4-5 minutes after reaching a stable temperature)
- Aw Equilibrium method available

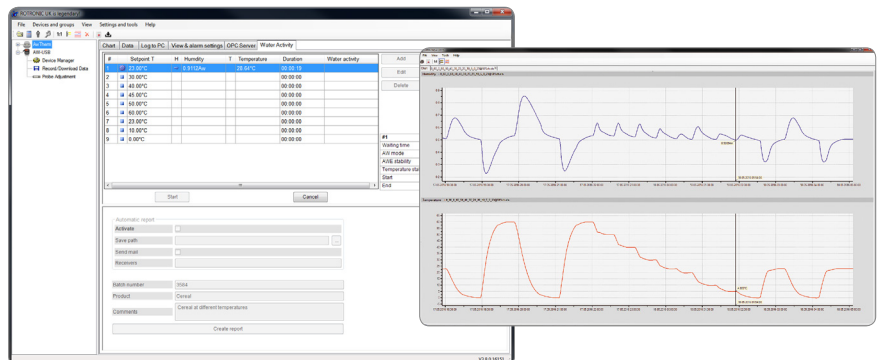

Fully automatic aw measurement can be planned if the AwTherm is connected to the HW4 software. The instrument then moves to preset temperature points automatically and carries out a pre-selected Aw Quick or Aw Equilibrium measurement.

PRODUCTS

HYGROLAB C1

Laboratory application

The HygroLab C1 is a laboratory analyzer for water activity measurements with up to four interchangeable measurement heads. The possibility to combine measurement heads and insertion probes makes the HygroLab C1 extremely flexible.

Order code

HygroLab C1

HygroLab C1-SET-40



Validated software

The HygroLab C1 is easy and intuitive to use. It offers a high degree of user friendliness and the possibility to connect the benchtop display unit to a PC running Rotronic HW4 software (included in the SET) using a USB cable and via the Ethernet.

The HW4 software can be used to configure instruments and as a remote control for the complete system.

Features

- 4-channel benchtop display unit for the measurement of water activity, relative humidity and temperature
- Aw Quick function for fast measurement results (typically 4-5 minutes)
- Aw Equilibrium method available
- Multi-channel display
- Suitable for applications throughout industry
- Audible alarm to indicate completed aw measurement

HYGROPALM23-AW-A

Mobile application

As a mobile laboratory unit, the HygroPalm HP23-AW-A is perfect for on-site water activity measurements to determine the stability and preservability of the sample being analyzed. Like the HygroLab C1, the HP23-AW-A can also be used with measurement heads or insertion probes (two can be connected). The HygroPalm can be controlled externally using the HW4 software running on a PC.



Order code

HP23-AW-A

HP23-AW-SET-14

HP23-AW-SET-40

Portable and handy

The handheld instrument for measurement of water activity has the same functions as the HygroLab C1, but is handier in its portable version.

Features

- 2-channel handheld instrument with multi-channel display for measurement of water activity, relative humidity and temperature
- Aw Quick function for fast measurement results (typically 4 – 5 minutes)
- Aw Equilibrium method available
- Audible alarm to indicate completed measurement
- Saves up to 10,000 measured values
- Battery charging function via a USB mains adapter cable (AC1212)

PRODUCTS

AW MEASUREMENT HEAD HC2-AW

The aw measurement head was developed for use in combination with the HygroLab C1 and the HP23-A-AW handheld analyser. This digital probe enables quick and easy measurement of water activity. It can be calibrated via the HygroLabC1, HP23-A-AW or via the HW4 PC software.

The sample holder size is reduced to a minimum, thereby making it possible for humidity equilibrium to be reached quickly for all products being tested, while the metal housing ensures high temperature stability. All critical surfaces are made of chrome steel for minimal soiling.

You can find information on sample holders, disposable plastic sample containers and the clamp sealing mechanism under Accessories on the Rotronic website and in the main catalogue.

Order code

HC2-AW



AW MEASUREMENT HEAD HC2-AW-USB

This USB measurement head can be connected directly to a PC and comes in a set including software or as a single instrument for addition to a system.

The set HC2-AW-USB-SW contains the HW4 software with AW Quick function, thereby opening up all the possibilities of water activity measurement. It can be extended into a multi-station application with up to 64 measurement heads used with a powered USB hub.

Features

- Measurement range: 0...1.00 aw (0...100 %RH), -40...85 °C
- Direct USB PC connection

Order code

HC2-AW-USB

HC2-AW-USB-SW



CLAMP SEALING MECHANISM

Under certain circumstances additional mechanical sealing of the AW measurement station and sample holder may be necessary to prevent external conditions influencing the sample. The AW-KHS ensures a strong mechanical seal and is compatible with the WP-40 and WP-40TH sample holders.

Order code

AW-KHS



PRODUCTS

AW INSERTION PROBES HC2-P05, HC2-HP28, HC2-HP50

Direct measurement

This probe is suitable for direct measurement of water activity in bulk material samples such as powder, granulated materials, corn and grain. The HC2-HP is equipped with a robust stainless steel probe with a diameter of 10 mm and interchangeable sinter steel dust filter for measurement in dusty bulk materials. The HC2-P05 is the ideal measuring instrument for dust-free applications such as tablets, gel capsules and granulated plastics.

Features

- 5 mm insertion probe, for water activity measurement in dust-free bulk materials (P05)
- 10 mm insertion probe for water activity measurement in dusty bulk materials (HC2-HP28 and HC2-HP50)

Order code

HC2-HP05

HC2-HP28

HC2-HP50

P05

HP28

HP50

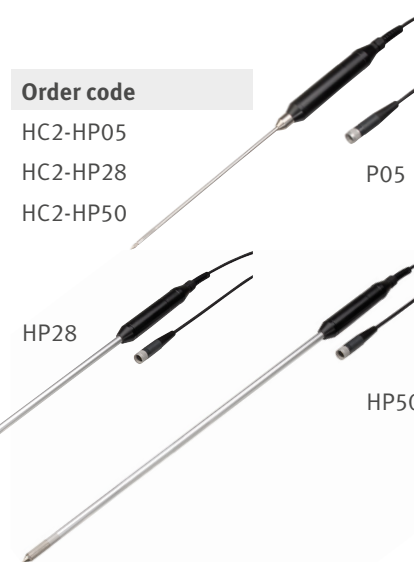

WATER ACTIVITY SETS

The different aw start sets contain everything needed to measure water activity and calibrate the measuring instruments to confirm sensor performance.

HP23-AW-SET-40



Order code

HP23-AW-SET-14

HP23-AW-SET-40

HygroLab C1-Set-40

AwTherm-Set

SAMPLE HOLDERS AND DISPOSABLE SAMPLE CONTAINERS

Sample holders and disposable sample containers

The sample holders ensure optimal temperature stability for the product. The WP-40TH sample holder can be combined with a water jacket for additional stabilization of the temperature.

The disposable sample containers (PS-14 and PS-40) ensure optimal utilization of the volume in the sample holder. They prevent the sample holders from coming into direct contact with the product being tested, thereby preventing soiling or cross contamination. The disposable sample containers also provide a convenient means of collecting and storing samples.

Order code

PS-14

PS-40

WP-14-S

WP-40

WP-40TH

PS-14

PS-40

WP-14-S

WP-40

WP-40TH



SOFTWARE

HW4 SOFTWARE

Full compatibility

The HW4 software is compatible with all Rotronic products with USB, UART or Ethernet interfaces and runs on all WINDOWS 7/8/10 operating systems.

Functions

- Live display of current measured values
- Recording of measured values
- Configuration of instruments
- Probe calibration and adjustment
- Online calculation of humidity and aw values
- Alarm function with e-mail
- AwQuick function (HW4-P-QUICK)
- Measurement within 4 – 5 minutes
- User management

Viewing of measured values / Monitoring

Viewing of measured values is very easy and user-friendly. Files of any device shown in the device tree can be copied and opened directly with the HW4 explorer. The data is presented in both tabular and graphical formats. The graph module can be configured by the user.

Instrument configuration

The HW4 PC software can be used to adjust the settings of Rotronic instruments and probes. Depending on the instrument and probe, the following functions and settings can be changed:

- general device settings
- password protection of device settings
- change the system units: metric / Imperial
- AwE and Aw Quick
- aw mode settings
- validation FDA 21 CFR part 11

Order code

HW4-P-Quick



PDF report available

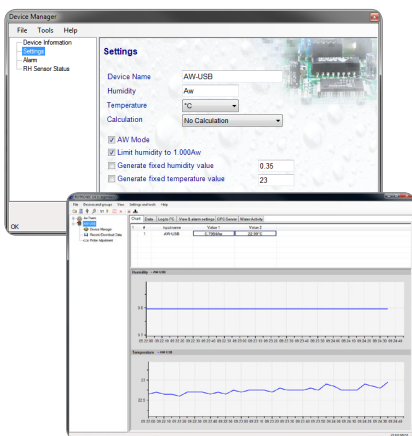

HW4 measured values shown graphically

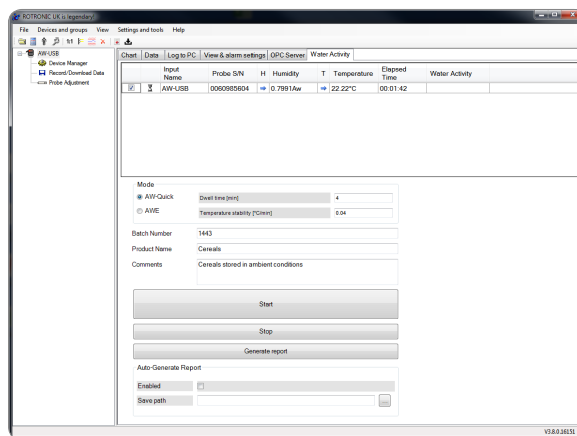

Water activity measurement setup with HW4 PC software

CALIBRATION

HYGROGEN2 S & XL

This mobile calibration system is appreciated around the world as it generates stable temperature and humidity conditions quickly and saves considerable time in the calibration of all types of humidity measuring instruments from all manufacturers.

The HygroGen2 calibrates measuring instruments across their complete working range and fulfills strict quality and conformity regulations, as a result of which it has become a leading instrument in its class particularly in the pharmaceutical industry.

The chamber volume of the XL version is 10 times greater than that of the HygroGen2-S, making it perfect for companies that need to calibrate a large number of probes and complete measuring instruments regularly.

CALIBRATION VARIANT ISO 17025

Arrange a calibration appointment with our SCS team and we will reserve our accredited equipment for your devices. Should your devices not attain ISO 17025 calibration, we will offer you a factory calibration certificate.

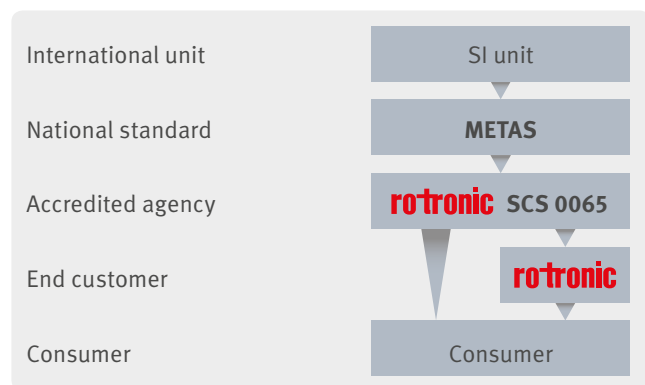

Validation: Rotronic offers validation of both the HygroLab C1 and the AwTherm. Please contact us for further details.

Order code

HG2-S
HG2-XL

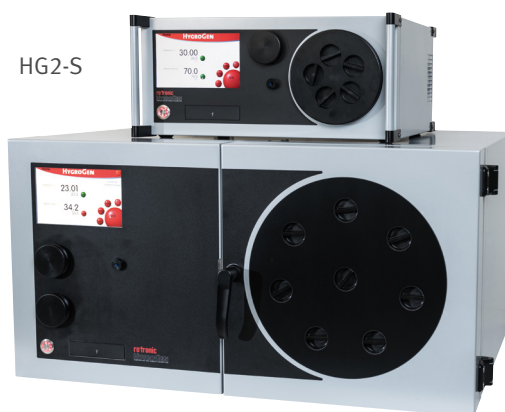

Order code	Nominal value	Measurement uncertainty at 23 °C
EA00-SCS	0.5 %RH	±0.3 %RH
EA10-SCS	10 %RH	
EA11-SCS	11.3 %RH	
EA20-SCS	20 %RH	±0.4 %RH
EA35-SCS	35 %RH	
EA50-SCS	50 %RH	±0.6 %RH
EA60-SCS	60 %RH	
EA65-SCS	65 %RH	
EA75-SCS	75.3 %RH	±0.7 %RH
EA80-SCS	80 %RH	
EA95-SCS	95 %RH	±0.8 %RH

SCS-CERTIFIED HUMIDITY STANDARDS

Enables end-user calibration and adjustment of Rotronic or third-party probes on site. With the Rotronic humidity standards, a calibration device, service cable and the HW4 software running on a PC, this is easy to do. The HygroLab C1 and HP23-A can also be calibrated and adjusted without software.

THEORY

HOW TO CARRY OUT A WATER ACTIVITY MEASUREMENT?

1. As a qualitative measurement it is important that variables are eliminated when performing measurements, this includes temperature and sample preparation.
2. Place a sample of the product to be measured into a sample cup (14 or 40 mm deep). Recommendation: fill up to within 3 mm of the rim if possible. The less air in the container, the faster the time to achieve equilibrium.

*Important: Do not allow the sample to touch the measurement probe head!
Contamination of the measurement head will falsify all other measurements made with other product samples.*

3. Place the sample cup into the sample holder.
4. Close the lid or place the measurement head on the sample holder.

Important: the probe and sample holder must form a tight seal. Only with this seal is the system closed and equilibrium can be achieved. Rotronic manufactures a clamp sealing mechanism.

5. Water activity can be measured in two ways. Either using a predictive model or by waiting until the water vapor pressure and the temperature have reached equilibrium within the measurement chamber. Rotronic devices have a predictive model, the AwQuick, embedded software to perform this process quickly and repeatably.

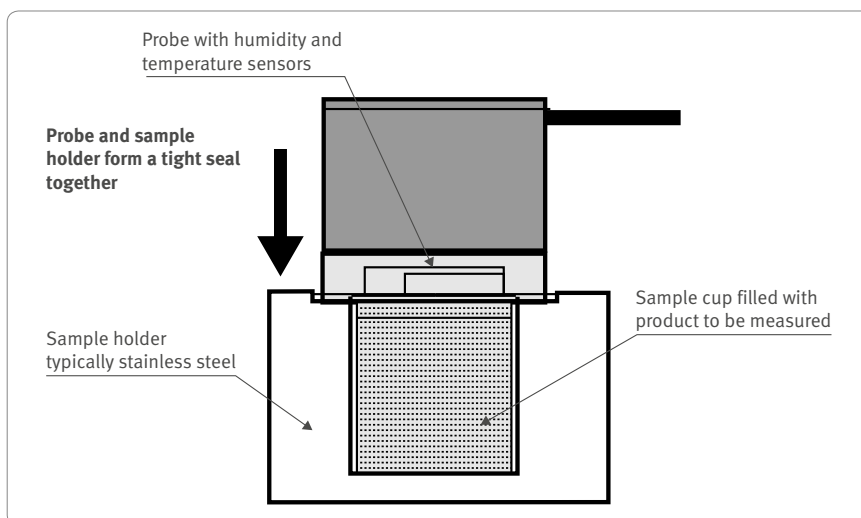

Cross section HC2-AW with WP-40

TEMPERATURE CONTROL?

Water activity is sensitive to temperature. Measurements can only be made when the product sample, sample holder and measurement sensors are at stable temperatures. Many standards require measurements to be made at a specific temperature.

In situations where ambient temperature cannot be controlled or where you wish to test samples at temperatures away from ambient a temperature controlled system should be used. Rotronic provides measurement solutions for both applications, in each case our instruments are designed to maintain stable temperature through the use of large thermal mass or active thermal control.

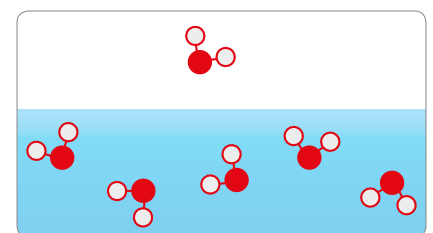

Measurement sample not yet in equilibrium

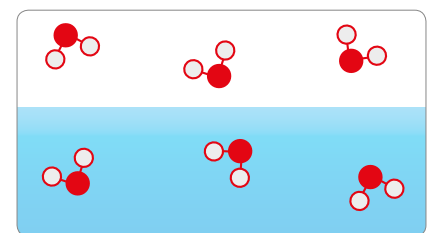

Measurement sample in equilibrium

